



### Features

- Fixed 4.9V  $\pm$  2% Output
- VIN Range: 2.7V to 4.5V
- Output Current: Up to 110mA (VIN $\geq$ 3V)  
Up to 230mA (VIN $\geq$ 3.6V)
- Low Noise Constant Frequency (360kHz) Operation
- Shutdown Current <1 $\mu$ A
- No Inductors
- Available in Low Profile 6-Lead SOT23 Package

### Applications

- White LED Backlighting
- Li-Ion Battery Backup Supplies
- Smart Card Readers
- PCMCIA Local 5V Supplies

### Description

The HX4004A is a low noise switched capacitor voltage doubler. It produce a regulated output voltage from a 2.7V to 4.5V input. Low external parts count (one flying capacitor and two small bypass capacitors at VIN and VOUT) make the HX4004A ideally suited for small, battery-powered applications.

The HX4004A have thermal shutdown capability and can survive a continuous short circuit from VOUT to GND. A low current shutdown feature disconnects the load from VIN and reduces quiescent current to <1 $\mu$ A.

The HX4004A is available in the industry standard SOT-23-6L power packages.

## Typical Application

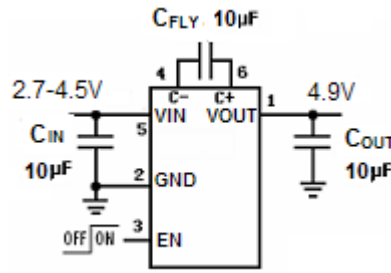
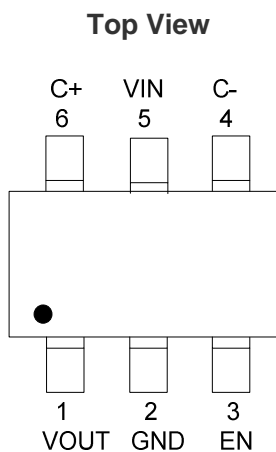

Figure 1: Regulated 4.9V Output

## Pin Description



PIN NUMBER SOT-23-6L	PIN NAME
1	VOUT
2	GND
3	EN
4	C-
5	VIN
6	C+

SOT-23-6L

## Absolute Maximum Ratings (Note 1)

- $V_{IN}$  ..... - 0.3V to 6V
- $V_{OUT}$ .....- 0.3V to 5.5V
- $V_{OUT}$  Short-circuit Duration.....indefinite
- $V_{EN}$ .....- 0.3V to 6V
- $I_{OUT}$  (Note 2) ..... 300mA
- Operating Temperature Range (Note 3).....- 30°C to 85°C
- Lead Temperature (Soldering 10 sec.) .....300°C
- Storage Temperature Range .....- 65°C to 125°C

**Note 1:** Absolute Maximum Ratings are those values beyond which the life of a device may be impaired.

**Note 2:** Based on long term current density limitations.

**Note 3:** The HX4004A are guaranteed to meet performance specifications from 0°C to 70°C. Specifications over the -40°C to 85°C operating temperature range are assured by design, characterization and correlation with statistical process controls.

## Electrical Characteristics

The specifications are at  $T_A = 25\text{ }^\circ\text{C}$ .  $EN = V_{IN}$ ,  $C_{IN} = C_{OUT} = C_{FLY} = 10\mu\text{F}$ , unless otherwise noted.

PARAMETER	CONDITIONS	MIN	TYP	MAX	UNITS
Input Voltage Range ( $V_{IN}$ )		2.7		4.5	V
Output Voltage Range ( $V_{OUT}$ )	$2.7\text{V} < V_{IN} < 5.5\text{V}$ , $I_{OUT} < 65\text{mA}$	4.83	4.9	4.97	V
$I_{SHDN}$ Shutdown Current	$EN = 0\text{V}$ , $V_{OUT} = 0\text{V}$		0.2		$\mu\text{A}$
No Load Input Current	$I_{OUT} = 0\text{mA}$ , $V_{IN} = 3\text{V}$		0.17		mA
Output Ripple (VR)	$V_{IN} = 3.6\text{V}$ , $I_{OUT} = 100\text{mA}$		20		mVP-P
Efficiency	$V_{IN} = 3\text{V}$ , $I_{OUT} = 100\text{mA}$		78		%
Switching Frequency ( $f_{osc}$ )	$V_{IN} = 3.6\text{V}$ , $I_{OUT} = 100\text{mA}$		360		kHz

$$\star \text{ EFFI} = [(\text{Output Voltage} \times \text{Output Current}) / (\text{Input Voltage} \times \text{Input Current})] \times 100\%$$

## Typical Performance Characteristics

$T_A = 25\text{ }^\circ\text{C}$ ,  $EN = V_{IN}$ ,  $C_{IN} = 10\mu\text{F}$ ,  $C_{OUT} = 10\mu\text{F}$ ,  $C_{FLY} = 10\mu\text{F}$ , unless otherwise noted.

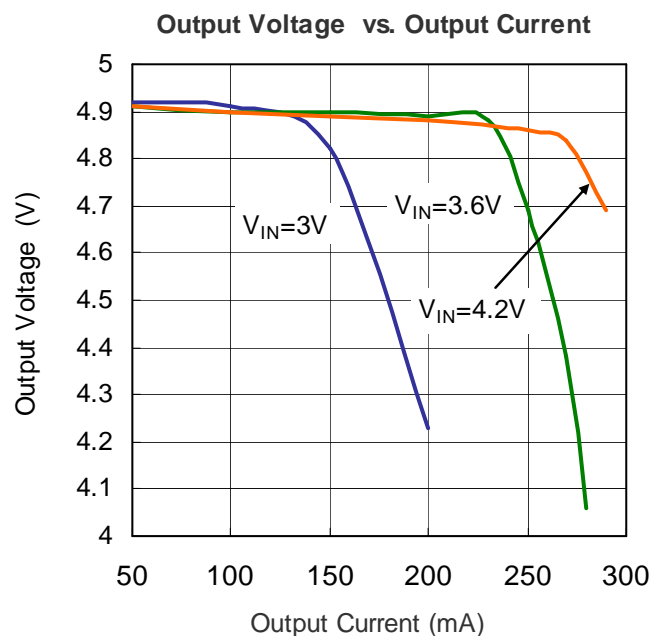
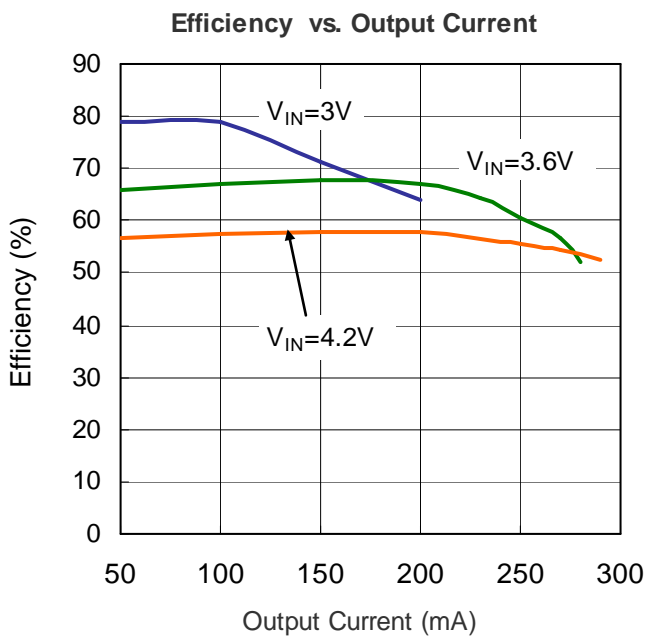

**Output Voltage vs. Supply Voltage  
(ILOAD=0mA)**

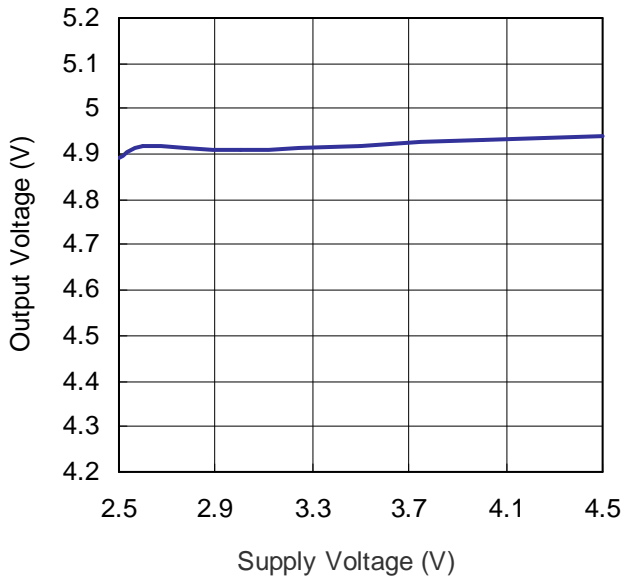

**Supply Current vs. Supply Voltage  
(ILOAD=0mA)**

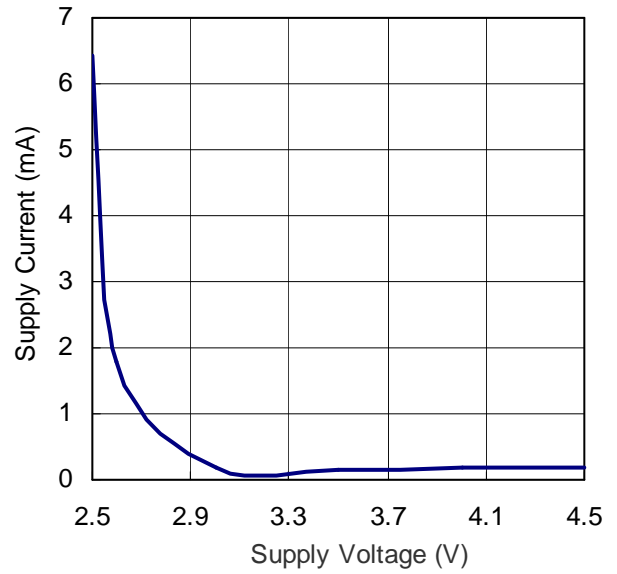

**Oscillator Frequency vs. Supply Voltage  
(ILOAD=100mA)**

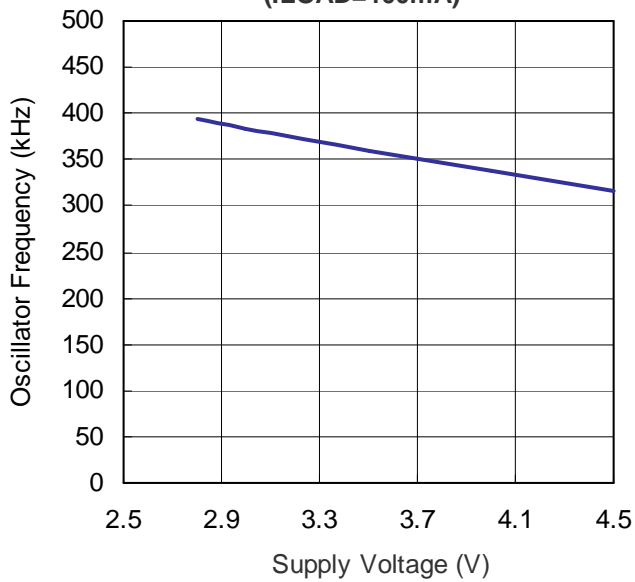

**Output Noise ( $V_{IN}=3.6V, I_{LOAD}=100mA$ )**

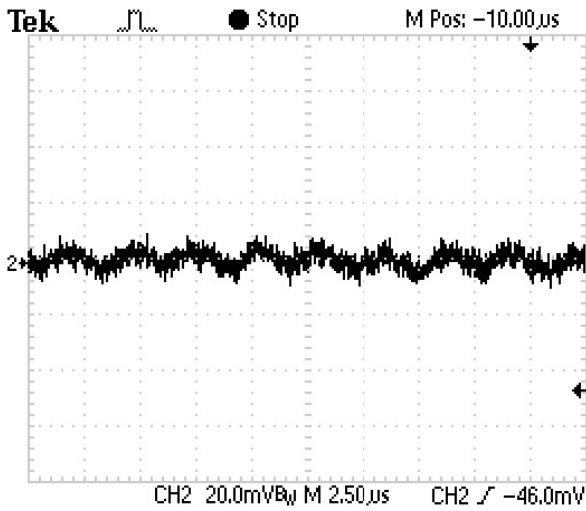

**SW Noise ( $V_{IN}=3.6V, I_{LOAD}=100mA$ )**

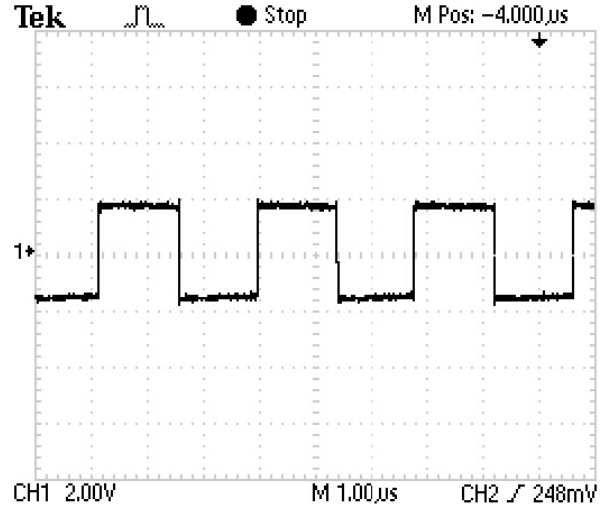

**Output Noise ( $V_{IN}=4.2V, I_{LOAD}=100mA$ )**

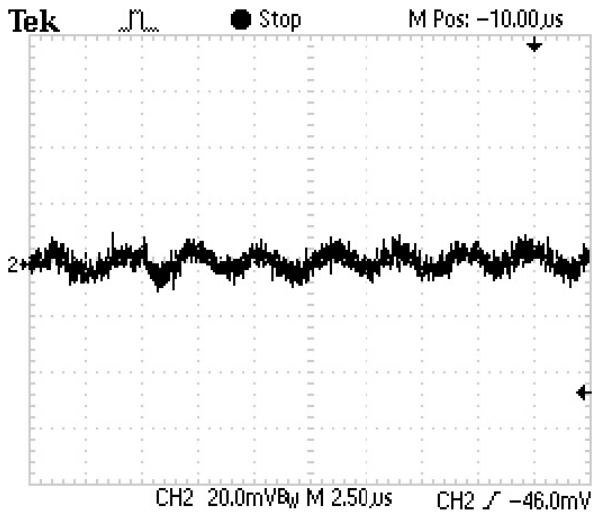

**SW Noise ( $V_{IN}=4.2V, I_{LOAD}=100mA$ )**

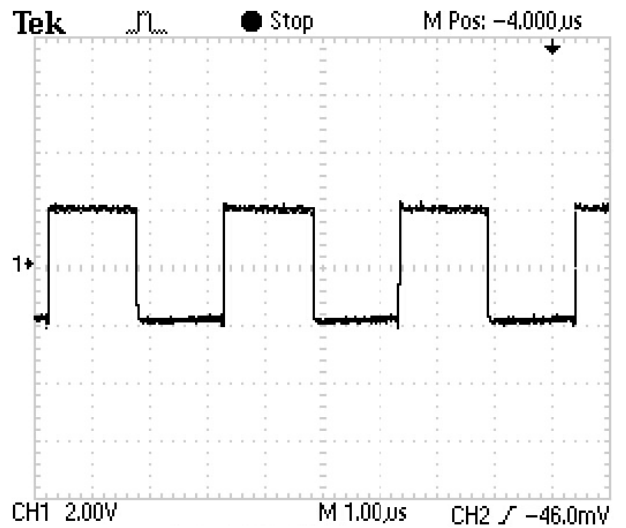

## Pin Functions

**VOUT (Pin 1):** Regulated Output Voltage. VOUT should be bypassed with a low ESR ceramic capacitor providing at least 10 $\mu$ F of capacitance as close to the pin as possible for best performance.

**GND (Pin 2):** Ground. These pins should be tied to a ground plane for best performance.

**EN (Pin 3):** Active Low Shutdown Input. This pin must not be allowed to float.

**C- (Pin 4):** Flying Capacitor Negative Terminal.

**VIN (Pin 5):** Input Supply Voltage. VIN should be bypassed with a low ESR ceramic capacitor providing at least 10 $\mu$ F of capacitance as close to the pin as possible for best performance.

**C+ (Pin 6):** Flying Capacitor Positive Terminal.

## Block Diagram

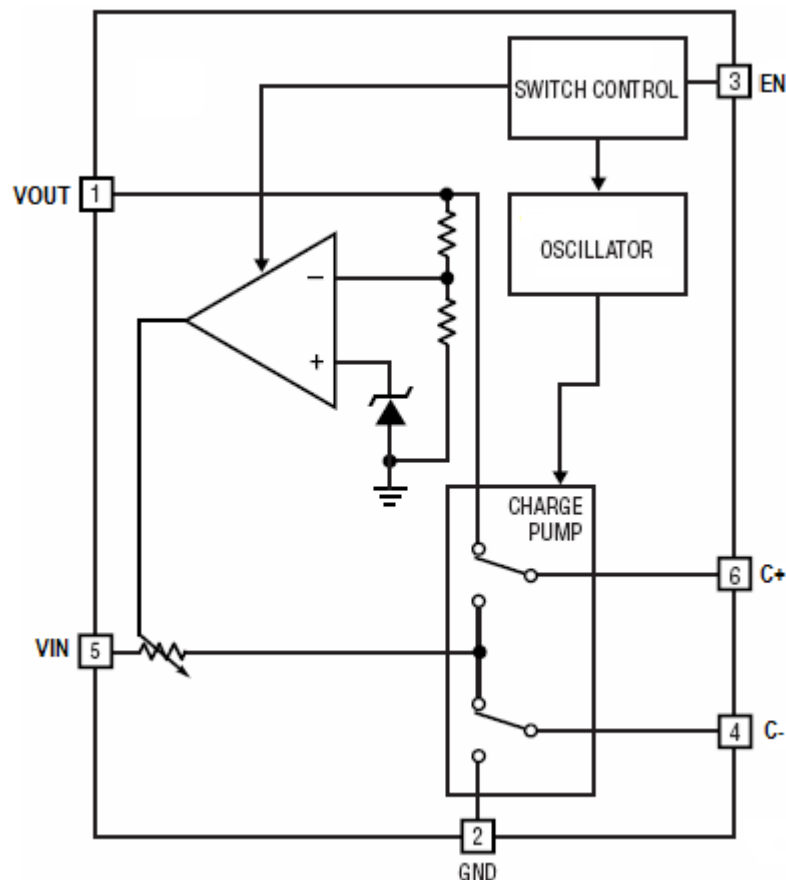

## Application Information

### Operation

The HX4004A use a switched capacitor charge pump to boost VIN to a regulated output voltage. Regulation is achieved by sensing the output voltage through an internal resistor divider and modulating the charge pump output current based on the error signal. A 2-phase nonoverlapping clock activates the charge pump switches. The flying capacitor is charged from VIN on the first phase of the clock. On the second phase of the clock it is stacked in series with VIN and connected to VOUT. This sequence of charging and discharging the flying capacitor continues at a free running frequency of 360kHz (typ).

In shutdown mode all circuitry is turned off and the HX4004A draw only leakage current from the VIN supply. Furthermore, VOUT is disconnected from VIN. The EN pin is a CMOS input with a threshold voltage of approximately 0.8V. The HX4004A is in shutdown when a logic low is applied to the EN pin. Since the EN pin is a high impedance CMOS input it should never be allowed to float. To ensure that its state is defined it must always be driven with a valid logic level.

### VIN, VOUT Capacitor Selection

The style and value of capacitors used with the HX4004A determine several important parameters such as regulator control loop stability, output ripple, charge pump strength and minimum start-up time.

To reduce noise and ripple, it is recommended that low ESR ( $< 0.1\Omega$ ) ceramic capacitors be used for both CIN and COUT. These capacitors should be 10uF or greater. Tantalum and aluminum capacitors are not recommended because of their high ESR.

### Flying Capacitor Selection

Warning: A polarized capacitor such as tantalum or aluminum should never be used for the flying capacitor since its voltage can reverse upon start-up of the HX4004A. Low ESR ceramic capacitors should always be used for the flying capacitor.

The flying capacitor controls the strength of the charge pump. In order to achieve the rated output current it is necessary to have at least 10uF of capacitance for the flying capacitor.

### Layout Considerations

Due to its high switching frequency and the high transient currents produced by the HX4004A, careful board layout is necessary. A true ground plane and short connections to all capacitors will improve performance and ensure proper regulation under all conditions. Figure 2 shows an example layout for the HX4004A.

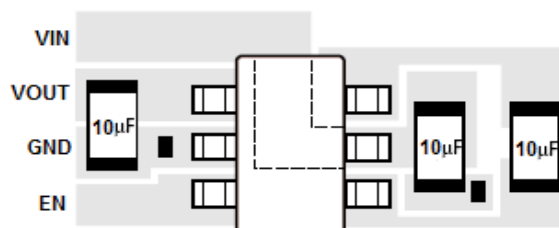
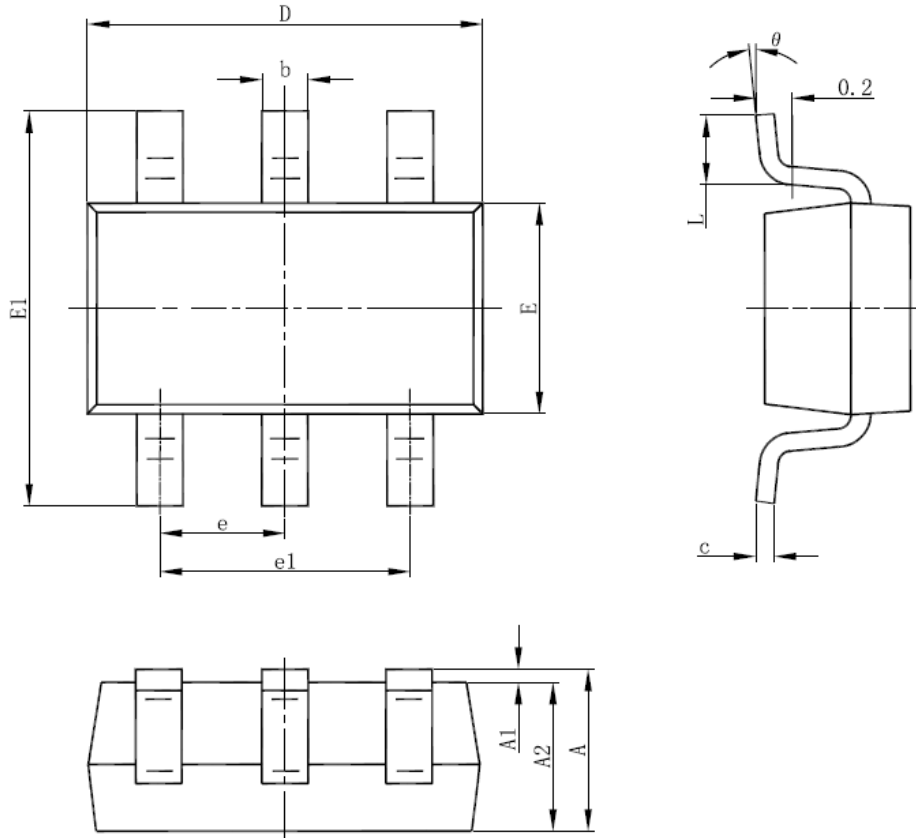

Figure 2: Recommended Layout

## Packaging Information

### SOT-23-6L Package Outline Dimension



Symbol	Dimensions In Millimeters		Dimensions In Inches	
	Min	Max	Min	Max
A	1.050	1.250	0.041	0.049
A1	0.000	0.100	0.000	0.004
A2	1.050	1.150	0.041	0.045
b	0.300	0.500	0.012	0.020
c	0.100	0.200	0.004	0.008
D	2.820	3.020	0.111	0.119
E	1.500	1.700	0.059	0.067
E1	2.650	2.950	0.104	0.116
e	0.950(BSC)		0.037(BSC)	
e1	1.800	2.000	0.071	0.079
L	0.300	0.600	0.012	0.024
$\theta$	0°	8°	0°	8°